

4715MS (119[□] X 38^L)

EMINEBEA.COM

NMB

General Specifications

Allowable Ambient Temperature Range:

-10°C ~ +70°C (Operating)

-40°C ~ +70°C (Storage)

(non-condensing environment)

Motor Structure: Shaded Pole Induction Motor

Motor Protection: Impedance Protection

Outline

Units: inch
(mm)

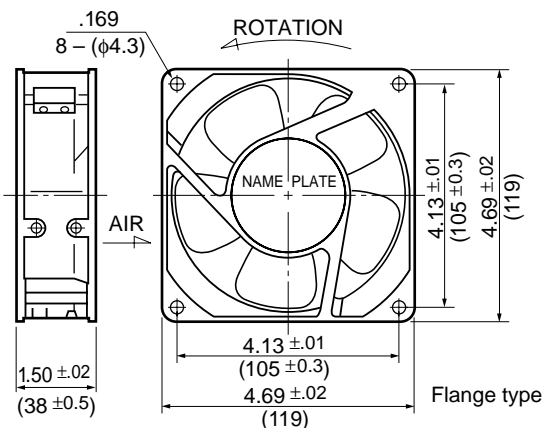

Panel Cut-outs

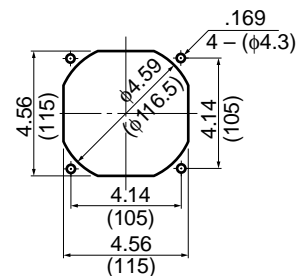

INLET SIDE / OUTLET SIDE

Material

Casing : Aluminum

Impeller : Polycarbonate (Glass Fiber-Containing)

Bearing : Ball Bearings

Lead Wire: AWG22, UL3266, CSA CLR52

or Terminal: Faston #110 or equivalent

Characteristic Curves

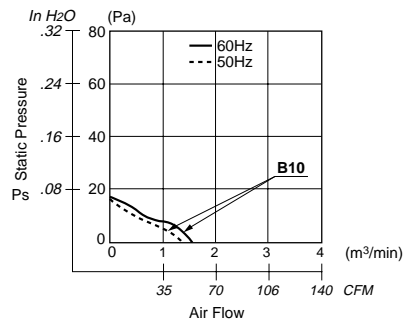
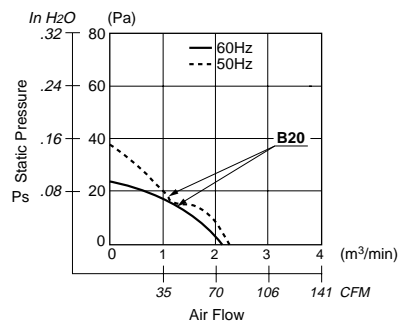
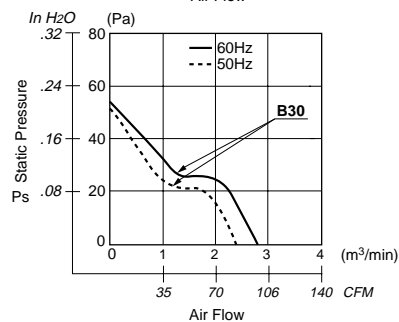
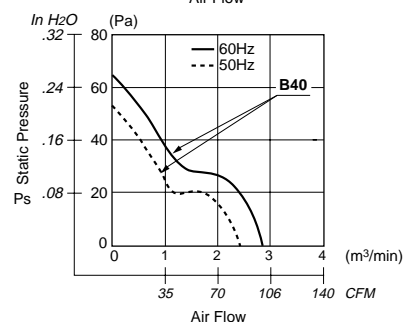
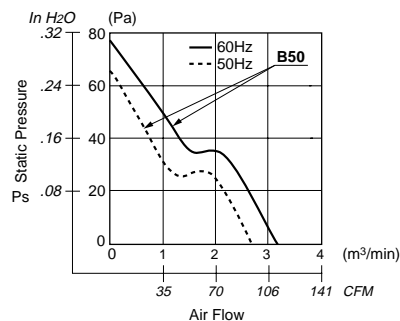

4715MS (119[□] x 38^L)

NMB

EMINEBEA.COM

Specifications

AC Axial Fans

MODEL	Rated Voltage	Frequency	Starting Voltage	Current	Input Power	Speed	Max. Air Flow		Max. Static Pressure		Noise	Mass
	(V)	(Hz)	(V)	(A) ^{*1}	(W) ^{+10% -20%}	(min ⁻¹) ^{*2}	CFM ^{*2}	(m ³ /min) ^{*2}	in HzO	(Pa) ^{*2}	(dB) ^{*2}	(g)
4715MS-10T-B50-B00	100	50	65	0.270	15.0	2600	88.25	2.50	.259	64.6	37.0	550
	100	60	65	0.230	14.0	2900	102.0	2.90	.306	76.4	41.0	550
4715MS-12T-B50-A00	115	50	65	0.250	15.5	2600	88.2	2.50	.259	64.6	37.0	550
	115	60	65	0.210	14.5	2900	102.0	2.90	.306	76.4	41.0	550
4715MS-20T-B50-B00	200	50	130	0.140	15.0	2600	88.25	2.50	.259	64.6	37.0	550
	200	60	130	0.120	13.0	2900	102.0	2.90	.306	76.4	41.0	550
4715MS-22T-B50-B00	220	50	145	0.120	14.0	2600	88.25	2.50	.255	63.7	37.0	550
	220	60	145	0.100	13.0	2900	102.0	2.90	.302	75.4	41.0	550
4715MS-23T-B50-A00	230	50	175	0.120	15.0	2600	88.2	2.50	.255	63.7	37.0	550
	230	60	175	0.100	14.0	2900	102.0	2.90	.283	70.5	41.0	550
4715MS-24T-B50-A00	240	50	140	0.110	14.0	2600	88.25	2.50	.255	63.7	37.0	550
	240	60	140	0.100	13.0	2900	102.0	2.90	.363	65.6	41.0	550
4715MS-10T-B40-B00	100	50	65	0.250	15.0	2450	85.0	2.40	.204	50.9	35.0	550
	100	60	65	0.220	13.0	2750	95.0	2.70	.251	62.7	39.0	550
4715MS-12T-B40-A00	115	50	75	0.220	15.0	2450	85.0	2.40	.204	50.9	35.0	550
	115	60	75	0.190	13.0	2750	95.0	2.70	.259	64.6	39.0	550
4715MS-20T-B40-B00	200	50	130	0.130	15.0	2450	85.0	2.40	.204	50.9	35.0	550
	200	60	160	0.110	13.0	2750	95.0	2.70	.255	63.7	39.0	550
4715MS-22T-B40-B00	220	50	145	0.110	14.0	2450	85.0	2.40	.216	53.9	35.0	550
	220	60	145	0.100	12.0	2750	95.0	2.70	.255	63.7	39.0	550
4715MS-23T-B40-A00	230	50	175	0.120	15.0	2450	85.0	2.40	.216	53.9	35.0	550
	230	60	175	0.100	13.0	2750	95.0	2.70	.255	63.7	39.0	550
4715MS-24T-B40-A00	240	50	140	0.100	13.0	2450	85.0	2.40	.204	50.9	35.0	550
	240	60	140	0.080	12.0	2750	95.0	2.70	.236	58.8	39.0	550
4715MS-10T-B30-B00	100	50	65	0.190	11.0	2400	81.0	2.30	.200	49.9	34.0	550
	100	60	65	0.170	10.0	2600	88.2	2.50	.204	50.9	37.0	550
4715MS-12T-B30-A00	115	50	75	0.160	11.0	2400	81.0	2.30	.200	49.9	34.0	550
	115	60	75	0.140	10.0	2600	88.2	2.50	.200	49.9	37.0	550
4715MS-20T-B30-B00	200	50	130	0.090	10.0	2400	81.0	2.30	.193	48.0	34.0	550
	200	60	130	0.080	10.0	2600	88.2	2.50	.185	46.0	37.0	550
4715MS-22T-B30-B00	220	50	145	0.090	11.0	2400	81.0	2.30	.197	49.0	34.0	550
	220	60	145	0.080	10.0	2600	88.2	2.50	.189	47.0	37.0	550
4715MS-23T-B30-A00	230	50	175	0.100	12.0	2400	81.0	2.30	.197	49.0	34.0	550
	230	60	175	0.080	11.0	2600	88.2	2.50	.208	51.9	37.0	550
4715MS-24T-B30-A00	240	50	140	0.090	12.0	2400	81.0	2.30	.197	49.0	34.0	550
	240	60	140	0.080	11.0	2600	88.2	2.50	.204	50.9	37.0	550
4715MS-10T-B20-B00	100	50	65	0.130	8.0	2100	76.5	2.00	.141	35.2	32.0	550
	100	60	65	0.120	8.0	1950	67.0	1.90	.098	24.5	30.0	550
4715MS-12T-B20-A00	115	50	75	0.100	7.0	2100	70.6	2.00	.141	35.2	32.0	550
	115	60	75	0.100	7.0	1950	67.0	1.90	.098	24.5	30.0	550
4715MS-20T-B20-B00	200	50	130	0.060	7.0	2100	70.6	2.00	.129	32.3	32.0	550
	200	60	130	0.060	7.0	1950	67.0	1.90	.082	20.5	30.0	550
4715MS-22T-B20-B00	220	50	145	0.060	7.0	2100	70.6	2.00	.125	31.3	32.0	550
	220	60	145	0.060	7.0	1900	67.0	1.90	.078	19.6	30.0	550
4715MS-23T-B20-A00	230	50	175	0.060	7.5	2100	70.6	2.00	.141	35.2	32.0	550
	230	60	175	0.060	7.5	1900	67.0	1.90	.086	21.5	30.0	550
4715MS-24T-B20-A00	240	50	175	0.060	8.0	2100	70.6	2.00	.153	38.2	32.0	550
	240	60	175	0.060	8.0	1900	67.0	1.90	.098	24.5	30.0	550
4715MS-10T-B10-B00	100	50	65	0.110	7.0	1350	45.9	1.30	.066	16.6	27.0	550
	100	60	65	0.110	6.5	1450	49.4	1.40	.066	16.6	28.0	550
4715MS-12T-B10-A00	115	50	75	0.090	6.0	1350	45.9	1.30	.062	15.6	27.0	550
	115	60	75	0.080	5.5	1450	49.4	1.40	.066	16.6	28.0	550
4715MS-20T-B10-B00	200	50	130	0.055	6.0	1350	45.9	1.30	.059	14.7	27.0	550
	200	60	130	0.050	5.0	1450	49.4	1.40	.059	14.7	28.0	550
4715MS-22T-B10-B00	220	50	145	0.050	6.0	1350	45.9	1.30	.059	14.7	27.0	550
	220	60	145	0.040	5.5	1450	49.4	1.40	.059	14.7	28.0	550
4715MS-23T-B10-A00	230	50	175	0.050	6.5	1350	45.9	1.30	.059	14.7	27.0	550
	230	60	175	0.045	6.0	1450	49.4	1.40	.059	14.7	28.0	550
4715MS-24T-B10-A00	240	50	175	0.050	6.5	1350	45.9	1.30	.062	15.6	27.0	550
	240	60	175	0.045	6.0	1450	49.4	1.40	.066	16.6	28.0	550

Rotation: Counterclockwise

Airflow Outlet: Air Out Over Struts

*1: Maximum Values in Free Air

*2: Average Values in Free Air