

# 80K-40/80K-6

## High Voltage Probe

### *Instructions*

The 80K-40/80K-6 High Voltage Probe (the probe or Product) is a high voltage accessory probe that extends the voltage measurements of an ac/dc voltmeter:

- 80K-40 up to 40 000 volts peak ac or dc
- 80K-6 up to 6000 volts peak ac or dc

The probe takes measurements on energy-limited circuits within the equipment. Examples include the high voltage in televisions or photo copy machines. A 1000:1 voltage divider provides the probes with a high input impedance that minimizes circuit loading and optimizes the measurement accuracy. The molded plastic body houses the divider and protects the user from hazardous voltage.

### ***How to Contact Fluke***

To contact Fluke, call one of the following telephone numbers:

- Technical Support USA: 1-800-44-FLUKE (1-800-443-5853)
- Calibration/Repair USA: 1-888-99-FLUKE (1-888-993-5853)
- Canada: 1-800-36-FLUKE (1-800-363-5853)
- Europe: +31 402-675-200
- Japan: +81-3-6714-3114
- Singapore: +65-6799-5566
- China: +86-400-921-0835
- Anywhere in the world: +1-425-446-5500

Or, visit Fluke's website at [www.fluke.com](http://www.fluke.com).

To register your product, visit <http://register.fluke.com>.

To view, print, or download the latest manual supplement, visit <http://us.fluke.com/usen/support/manuals>.

## Safety Information







A **Warning** identifies conditions and procedures that are dangerous to the user. A **Caution** identifies conditions and procedures that can cause damage to the Product or the equipment under test.

### Warning

To prevent possible electrical shock, fire, or personal injury:

- Read all safety information before you use the Product.
- Do not use the Product around explosive gas, vapor, or in damp or wet environments.
- Examine the case before you use the Product. Look for cracks or missing plastic.
- Do not use test leads if they are damaged. Examine the test leads for damaged insulation and measure a known voltage.
- Do not alter the Product and use only as specified, or the protection supplied by the Product can be compromised.
- When you do a measurement, never make body contact with the probe tip or red portion of the Product. Always hold the Product by its black handle.
- Do not use this probe to measure high voltages on power distribution systems.
- Connect the protective earth alligator clip lead to a known good earth ground.
- Do not apply more than the rated voltage between the terminals or between each terminal and earth ground.
- Have an approved technician repair the Product.
- Do not use the Product if it is altered or damaged.
- Disable the Product if it is damaged.

## Symbols

Symbol	Definition
	WARNING. HAZARDOUS VOLTAGE. Risk of electric shock.
	WARNING - RISK OF DANGER. Consult user documentation.
	Double Insulated
	Earth
	Conforms to European Union directives.
	Certified by CSA Group to North American safety standards.
	This product complies with the WEEE Directive marking requirements. The affixed label indicates that you must not discard this electrical/electronic product in domestic household waste. Product Category: With reference to the equipment types in the WEEE Directive Annex I, this product is classed as category 9 "Monitoring and Control Instrumentation" product. Do not dispose of this product as unsorted municipal waste.

## Operation

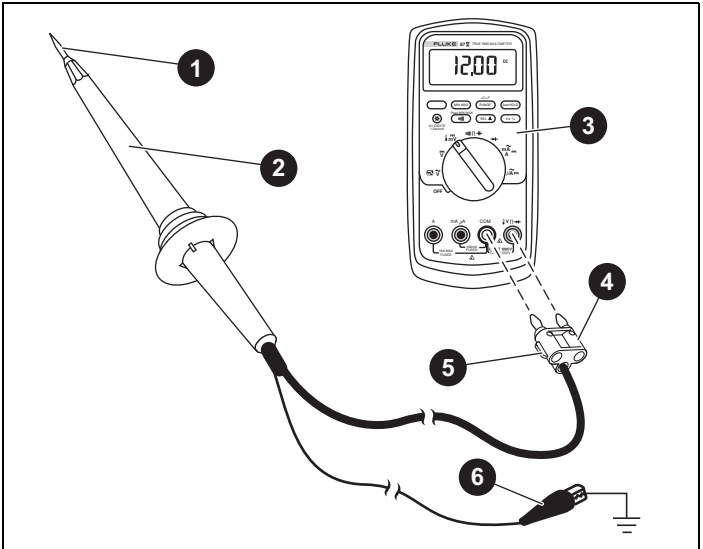

1	Probe tip
2	Probe body
3	Multimeter or voltmeter
4	Plug
5	GND tab
6	Protective earth ground lead clip

Use the probe as follows:

1. Inspect the probe.
2. Connect the ground lead of the probe to protective earth ground.
3. Connect the probe cable to a compatible voltmeter. Use a shunt resistor if required.
4. Select the 10 M $\Omega$  voltage range (1 V reading for 1000 V probe input).
5. Hold the probe by the black handle and connect the probe tip to the circuit.
6. Observe the voltmeter reading.

## Theory Of Operation

The probe is a passive attenuator. See Table 1. High input impedance, accuracy, and stability characteristics are achieved with thick-film resistors. When the probe is connected to a voltmeter with a  $10\text{ M}\Omega$  input resistance the probe becomes an accurate 1000:1 divider. This divider depends on a ground lead to complete the low side of the circuit path. The connection must always be secure before you do the voltage measurement. Otherwise, instrument damage or a shock hazard can result.

**Table 1. Schematic Diagram**

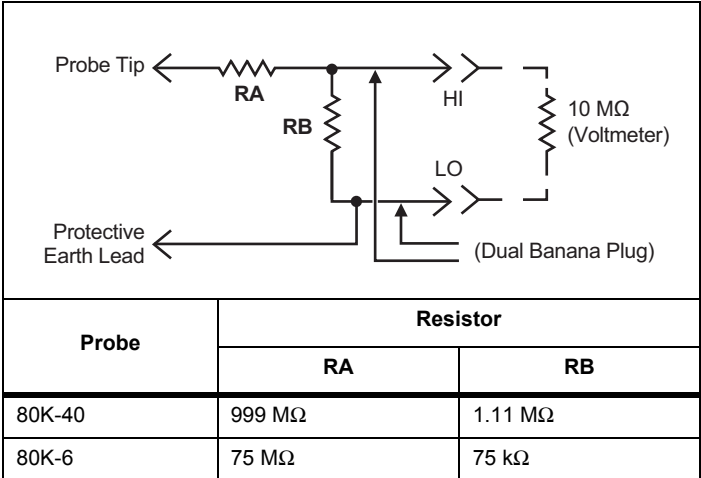

### Voltmeter Compatibility

Accuracy of the meter is not included in the accuracy of the probe and must be added to the probe accuracy to determine system accuracy.

The probe is mechanically compatible with any ac or dc voltmeter or multimeter that accepts a standard double banana connector (spaced 0.75" [19 mm]) with standard plugs (0.160" [4 mm]).

The probe is electrically compatible with any ac or dc voltmeter or multimeter that has an input impedance of:

- $10\text{ M}\Omega \pm 1\%$  for 80K-40
- $10\text{ M}\Omega \pm 10\%$  for 80K-6

Voltmeters or multimeters with other input impedances require the use of an external shunt or a correction factor to obtain an accurate measurement. Higher impedance voltmeters or multimeters should be equipped with a shunt, and lower impedance voltmeters or multimeters should be assigned correction factors.

Use this formula to determine the value of an external shunt resistor (meter impedance >10 MΩ):

$$R_s = \frac{R_m \times 10}{R_m - 10}$$

Where:  $R_s$  = Shunt resistance in MΩ  
 $R_m$  = Voltmeter input impedance in MΩ (>10 MΩ)

Example: If  $R_m = 20$  MΩ,

$$R_s = \frac{20 \times 10}{20 - 10} = \frac{200}{10} = 20 \text{ M}\Omega$$

Use this formula to calculate a correction factor (meter impedance <10 MΩ):

$$C_f = \frac{1.11 + R_m}{1.11 \times R_m}$$

Where:  $C_f$  = Correction factor (multiplier for meter reading)  
 $R_m$  = Voltmeter input impedance in MΩ

Example: If  $R_m = 1$  MΩ,

$$C_f = \frac{1.11 + 1}{1.11 \times 1} = \frac{2.11}{1.11} = 1.901$$

A meter reading of 0.526 volts represents an input of:  
 $0.526 \times 1.901 = 1$  or 1 kV

### **Circuit Loading**

The probe represents a load to the circuit:

- 1000 MΩ, or 1 μA/1 kV, for 80K-40
- 75 MΩ, or 13 μA/1 kV, for 80K-6

### **Maintenance**

The probe has no user-serviceable parts.

Use a soft cloth dampened with distilled water to clean the probe. Never use solvents or abrasive cleaners. Make sure the probes are dry before use.

### **Performance Test**

Verify the accuracy of the probe with a voltage source measurement:

- 25 kV dc ±0.25 % for 80K-40
- 5 kV dc ±0.25 % for 80K-6

When used with a compatible dc voltmeter, the probe should measure the source with ±1 % accuracy. No calibration adjustments are available on the probe.

### **Specifications**

Voltage Range

80K-40: 0 kV to ±40 kV dc or peak ac, 28 kV rms ac

80K-6: 0 kV to ±6 kV dc or peak ac, 4.24 kV rms ac

Input Resistance

80K-40: 1000 MΩ

80K-6: 75 MΩ nominal

Division Ratio: 1000:1 (1000 x attenuation)

Accuracy dc	
80K-40:	0 kV to 20 kV: 2 % 20 kV to 35 kV: $\pm 1$ % @ 20 °C to 30 °C, add 1 % @ 10 °C to <20 °C and >30 °C to 45 °C 35 kV to 40 kV: 2 %
80K-6:	0 kV to 6 kV: 1 %
Accuracy ac:	
80K-40:	5 % at 60 Hz
80K-6:	1 % dc to 500 Hz 2 % 500 Hz to 1 kHz -30 % typ. @ 10 kHz
Safety:	IEC 61010-031, Type B, Pollution Degree 2
Temperature	
Operating:	0 °C to 50 °C
Storage:	-20 °C to +60 °C
Relative Humidity:	80 % @ 30 °C 50 % @ 40 °C
Altitude	
80K-40:	2000 m, 2000 m to 5000 m: derate linearly the working voltage from 40 kV peak to 28 kV peak, and derate linearly the transient overvoltage from 60 kV peak to 44 kV peak
80K-6:	2000 m
Dimensions (L x W)	
80K-40:	36 cm x 7.5 cm (14 in x 3 in)
80K-6:	24.9 cm x 5.10 cm (9.8 in x 2.0 in)
Weight	
80K-40:	204 g (7.2 oz)
80K-6:	136 g (4.8 oz)

### LIMITED WARRANTY AND LIMITATION OF LIABILITY

This Fluke product will be free from defects in material and workmanship for one year from the date of purchase. This warranty does not cover fuses, disposable batteries, or damage from accident, neglect, misuse, alteration, contamination, or abnormal conditions of operation or handling. Resellers are not authorized to extend any other warranty on Fluke's behalf. To obtain service during the warranty period, contact your nearest Fluke authorized service center to obtain return authorization information, then send the product to that Service Center with a description of the problem.

THIS WARRANTY IS YOUR ONLY REMEDY. NO OTHER WARRANTIES, SUCH AS FITNESS FOR A PARTICULAR PURPOSE, ARE EXPRESSED OR IMPLIED. FLUKE IS NOT LIABLE FOR ANY SPECIAL, INDIRECT, INCIDENTAL OR CONSEQUENTIAL DAMAGES OR LOSSES, ARISING FROM ANY CAUSE OR THEORY. Since some states or countries do not allow the exclusion or limitation of an implied warranty or of incidental or consequential damages, this limitation of liability may not apply to you.

Fluke Corporation  
P.O. Box 9090  
Everett, WA 98206-9090  
U.S.A.

Fluke Europe B.V.  
P.O. Box 1186  
5602 BD Eindhoven  
The Netherlands

ООО «Флюк СИАЙЭС»  
125167, г. Москва,  
Ленинградский проспект дом 37,  
корпус 9, подъезд 4, 1 этаж