

R13-66

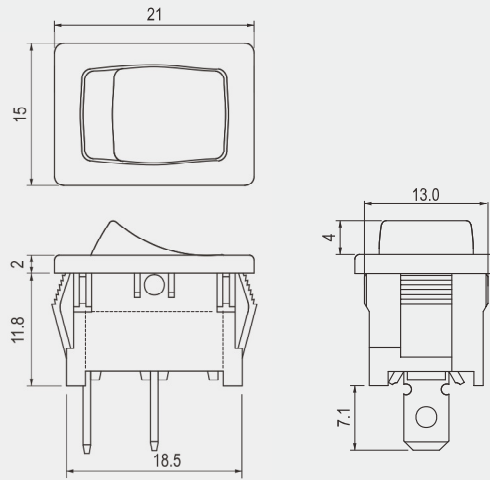
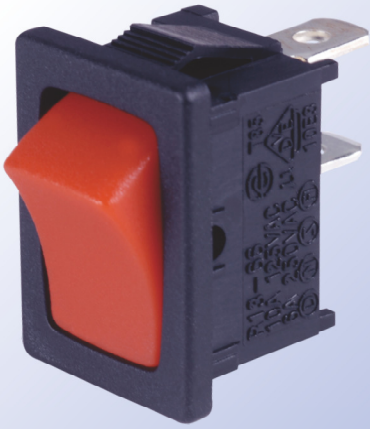

Rating

16A 125V AC 1/3HP 125V AC
 10A 250V AC 1/2HP 250V AC

Contact resistance

50mΩ Max

Insulation resistance

DC 500V 100MΩ Min

Dielectric strength

AC 1500V 1 minute

Cut-out



Actuator Height	X	Y
0.75~1.25	19.2~0.1	13.0~0.1
1.25~2.0	19.4~0.1	13.0~0.1
2.0~3.0	19.8~0.1	13.0~0.1

Cut-out for X8 ROCKER

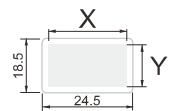

Actuator Height	X	Y
0.75~1.25	19.4~0.1	13.0~0.1
1.5~2.5	19.8~0.1	13.0~0.1

FEATURES

- * MATERIAL: Frame is nylon (UL flame: 94V-2). Terminals are silver plated brass.
- * Illuminated actuators are molded in PC, available with red, amber, green, blue and white colors.
- * Snap-in mounting, easy to install switch into panel.
- * Watertight cover is optional.
- * The only difference between R13-66B and R13-66B6 is the rocker style.

IP55



For watertight cover,
 Pls refer to page 8-3
 (R13-66A-29)



R13-66A3-02



R13-66B2-02



R13-66A8-02



R13-66B4-02



R13-66L-02

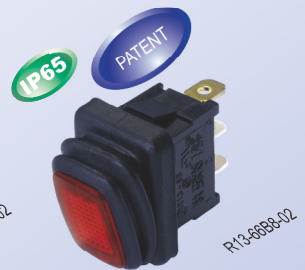

R13-66B8-02



R13-66B6-02



R13-66B5-02





R13-66AP-02

R13-66 

FUNCTION

TERMINAL





Different button (按鈕不同)

A  **A 5**  **A P** 

OFF 2P SPST ON OFF 2P SPST ON OFF 2P SPST ON

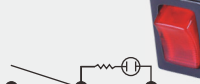
- 0 2  .187" SQ
- 0 5  SO
- 0 9  PC
- 1 0  PC ANGLE
- 1 2  SO

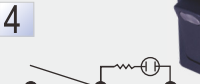
Illuminated / Different button (帶燈/按鈕不同)

B  **B 2**  **B 4**  **B 6** 

OFF 3P SPST (NEON) ON OFF 3P SPST (NEON) ON OFF 3P SPST (NEON) ON OFF 3P SPST (NEON) ON

125VAC 33KΩ / 250VAC 150KΩ 125VAC 33KΩ / 250VAC 150KΩ 125VAC 33KΩ / 250VAC 150KΩ 125VAC 33KΩ / 250VAC 150KΩ

ROCKER

A/B/BF/C/D/E/F
G/H/I



B, BF transparent



B2/B2F



L/B4/BF4



AP/CP/DP/HP/IP



B6/B6F





B6, B6F transparent

A8/B8/B8F/C8



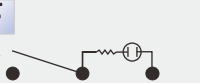
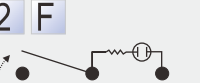



Momentary / Illuminated / Different button (彈回/帶燈/按鈕不同)

B F  **B 2 F**  **B 4 F**  **B 6 F** 

OFF 3P SPST (NEON) (ON) OFF 3P SPST (NEON) (ON) OFF 3P SPST (NEON) (ON) OFF 3P SPST (NEON) (ON)



125VAC 33KΩ / 250VAC 150KΩ 125VAC 33KΩ / 250VAC 150KΩ 125VAC 33KΩ / 250VAC 150KΩ 125VAC 33KΩ / 250VAC 150KΩ

Different position / Different button (動作特性不同/按鈕不同)



C  **C P**  **D**  **D P** 

ON 3P SPDT ON 3P SPDT ON OFF ON 3P SPDT ON OFF ON 3P SPDT

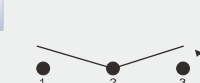
Momentary / Different button (彈回/按鈕不同)

E  **F**  **G**  **H** 

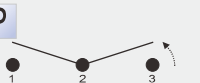
OFF 2P SPST ON OFF 2P SPST (ON) ON 3P SPDT (ON) (ON) OFF ON 3P SPDT

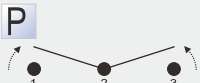
H P  **I**  **I P** 





(ON) OFF ON 3P SPDT (ON) OFF (ON) 3P SPDT (ON) OFF (ON) 3P SPDT

Independent circuit (獨立迴路)

L 

OFF 4P SPST (LED) ON

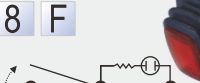
Watertight (防水)

A 8  **B 8**  **B 8 F**  **C 8**  **F 8** 

OFF 2P SPST ON OFF 3P SPST (NEON) ON OFF 3P SPST (NEON) (ON) ON ON 3P SPDT OFF (ON) 2P SPST

125VAC 33KΩ / 250VAC 150KΩ 125VAC 33KΩ / 250VAC 150KΩ