



IR-710

10:1 IR thermometer

Users Manual

- Mode d'emploi
- Bedienungshandbuch
- Manual d'Uso
- Manual de uso
- Användarhandbok



IR-710

10:1 IR thermometer

Users Manual

English

September 2011, Rev.1
©2011 Amprobe Test Tools.
All rights reserved. Printed in China

Limited Warranty and Limitation of Liability

Your Amprobe product will be free from defects in material and workmanship for 1 year from the date of purchase, unless local laws require otherwise. This warranty does not cover fuses, disposable batteries or damage from accident, neglect, misuse, alteration, contamination, or abnormal conditions of operation or handling. Resellers are not authorized to extend any other warranty on Amprobe's behalf. To obtain service during the warranty period, return the product with proof of purchase to an authorized Amprobe Test Tools Service Center or to an Amprobe dealer or distributor. See Repair Section for details. THIS WARRANTY IS YOUR ONLY REMEDY. ALL OTHER WARRANTIES - WHETHER EXPRESS, IMPLIED OR STATUTORY - INCLUDING IMPLIED WARRANTIES OF FITNESS FOR A PARTICULAR PURPOSE OR MERCHANTABILITY, ARE HEREBY DISCLAIMED. MANUFACTURER SHALL NOT BE LIABLE FOR ANY SPECIAL, INDIRECT, INCIDENTAL OR CONSEQUENTIAL DAMAGES OR LOSSES, ARISING FROM ANY CAUSE OR THEORY. Since some states or countries do not allow the exclusion or limitation of an implied warranty or of incidental or consequential damages, this limitation of liability may not apply to you.

Repair

All test tools returned for warranty or non-warranty repair or for calibration should be accompanied by the following: your name, company's name, address, telephone number, and proof of purchase. Additionally, please include a brief description of the problem or the service requested and include the test leads with the meter. Non-warranty repair or replacement charges should be remitted in the form of a check, a money order, credit card with expiration date, or a purchase order made payable to Amprobe® Test Tools.

In-Warranty Repairs and Replacement – All Countries

Please read the warranty statement and check your battery before requesting repair. During the warranty period any defective test tool can be returned to your Amprobe® Test Tools distributor for an exchange for the same or like product. Please check the "Where to Buy" section on www.amprobe.com for a list of distributors near you. Additionally, in the United States and Canada In-Warranty repair and replacement units can also be sent to a Amprobe® Test Tools Service Center (see address next page).

Non-Warranty Repairs and Replacement – US and Canada

Non-warranty repairs in the United States and Canada should be sent to a Amprobe® Test Tools Service Center. Call Amprobe® Test Tools or inquire at your point of purchase for current repair and replacement rates.

In USA

Amprobe Test Tools
Everett, WA 98203
Tel: 877-AMPROBE (267-7623)

In Canada

Amprobe Test Tools
Mississauga, ON L4Z 1X9
Tel: 905-890-7600

Non-Warranty Repairs and Replacement – Europe

European non-warranty units can be replaced by your Amprobe® Test Tools distributor for a nominal charge. Please check the "Where to Buy" section on www.amprobe.com for a list of distributors near you.

European Correspondence Address*

Amprobe® Test Tools Europe
In den Engematten 14
79286 Glottertal, Germany
Tel.: +49 (0) 7684 8009 - 0

*(Correspondence only – no repair or replacement available from this address. European customers please contact your distributor.)

IR-710 10:1 IR thermometer

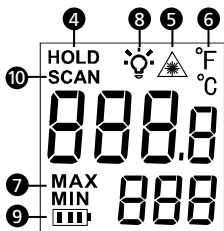
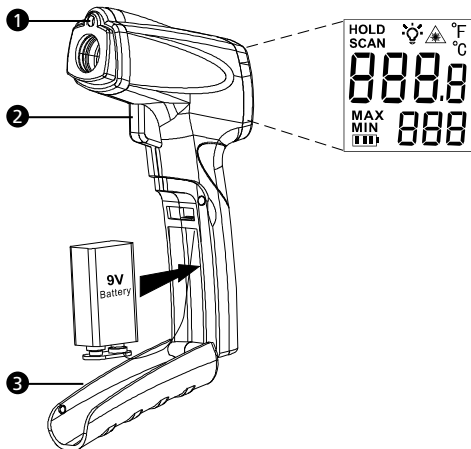





- 1 Laser Aperture
- 2 Trigger
- 3 Battery Cover
- 4 Display Hold
(After releasing the trigger)
- 5 Laser Indicator
- 6 Temperature Unit °C / °F
- 7 MAX / MIN Temperature
- 8 Display Backlight
- 9 Low Battery Indicator
- 10 Making Measurement
(Pulling the trigger)

CONTENTS

SYMBOLS	1
SAFETY INFORMATION	1
UNPACKING AND INSPECTION	3
FEATURES	3
HOW THE THERMOMETERS WORK	3
OPERATING THE THERMOMETER	4
Temperature Measurement.....	4
Locating a Hot or Cold Spot	5
Distance and Spot Size.....	5
Field of View.....	6
Emissivity	7
Reminders.....	7
SPECIFICATION	8
MAINTENANCE	10
TROUBLE SHOOTING	11
BATTERY REPLACEMENT	11

SYMBOLS

	Caution ! Refer to the explanation in this Manual.
	Warning! Laser light. Do not stare into laser beam.
°C	Celsius.
°F	Fahrenheit.
	Battery indication.
CE	Complies with European Directives.
	Do not dispose of this product as unsorted municipal waste. Contact a qualified recycler.

Safety Information

The instrument complies with:

EN 61010-1 General Safety

EN 60825-1 Laser Safety

EN 61326-1 Electromagnetic Emissions and Susceptibility



 Laser aperture

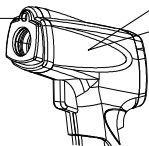

Warning: Read Before Using

- *Do not stare into laser beam.*
- *Do not point laser directly at eye or indirectly off reflective surfaces.*
- *For use by competent persons only.*
- *Do not point laser directly at eye or indirectly off reflective surfaces.*
- *Replace the batteries as soon as the low-battery indicator appears.*
- *Verify the Tester's operation by measuring on a known voltage source. Do not use the thermometer if it operates abnormally.*
- *Do not operate the thermometer around explosive gas, vapor, or dust.*
- *To avoid a burn hazard or fire, know that reflective objects may be much hotter than the indicated temperature reading.*
- *Do not leave the thermometer on or near objects of high temperature.*
- *If the thermometer is used in a manner not specified by this manual, the protection provided by the thermometer may be impaired or may result in hazardous laser radiation exposure.*

Cautions

To avoid damaging the thermometer under measurement, protect them from the following:

- *Do not stare into laser beam.*
- *EMF (electro-magnetic fields) from arc welders, induction heaters*
- *Static electricity*
- *Thermal shock (caused by large or abrupt ambient temperature changes — allow 30 minutes for instrument to stabilize before use)*
- *Do not leave the thermometer on or near objects of high temperature*

UNPACKING AND INSPECTION

Your shipping carton should include:

- 1 IR-710 Thermometer
- 1 9V battery (installed)
- 1 Users Manual

If any of the items are damaged or missing, return the complete package to the place of purchase for an exchange.

FEATURES

The Amprobe IR-710, a 10:1 spot to distance ratio infrared thermometer, offers best in class accuracy and response time with a temperature measurement range of 0°F to 716°F or -18°C to 380°C. The IR-710 is specifically designed for HVAC/R, electrical, industrial maintenance, automotive as well as quality control and fire prevention applications.

- 10:1 Distance to Spot Ratio
- Temp Range of 0°F to 716°F or -18°C to 380°C
- Precision accuracy and rapid response time
- Laser pointer, backlit dual LCD Display
- Auto display hold and MAX/MIN memory

HOW THE THERMOMETERS WORK

Infrared thermometers measure the surface temperature of an object. The thermometer's optics sense emitted, reflected, and transmitted energy, which is collected and focused onto a detector. The unit's electronics translate the signal into a temperature reading which the unit displays .

OPERATING THE THERMOMETER

Temperature Measurement



The Thermometer turns on when you press the trigger. The Thermometer turns off when no activity is detected for 8 seconds.

To measure temperature, point the thermometer at an object and pull the trigger. You can use the laser pointer to help aim the thermometer. Pull and hold the trigger when measuring the target surface.

When release the trigger, the display will hold the reading for 8 seconds. Be sure to consider distance-to-spot size ratio and field of view. The laser is used for aiming only and is not related to temperature measurement.

The thermometer features an auto off function that automatically powers down the thermometer after 8 seconds of inactivity. To turn the thermometer on, pull the trigger.



Button	Description.
°C °F	Toggle between Celsius and Fahrenheit.
MAX MIN	Toggle between MAX and MIN options. MAX or MIN reading is displayed on the secondary display.
 	Turn off or on the laser. Turn off or on display backlight.

Laser

To avoid injury, do not point the laser directly at eye or indirectly off reflective surfaces.

The thermometer is equipped with a laser used for aiming purposes only. The laser turns off when the trigger is released.

To enable or disable the laser:

1. Press button to enable or disable the laser. Symbol appears on the display when laser is enabled.

Locating a Hot or Cold Spot

To find a hot or cold spot, aim the Thermometer outside the target area. Then, slowly scan across the area with an up and down motion until you located the hot or cold spot.

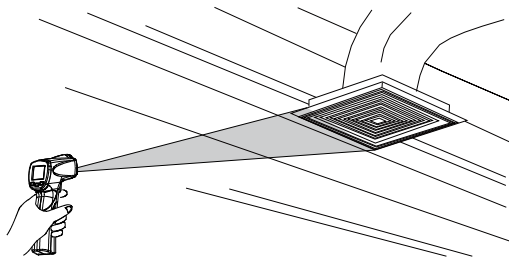

Distance and Spot Size

As the distance (D) from the target being measured increases, the spot size (S) of the area measured by the instrument becomes larger. The spot size indicates 90% encircled energy.

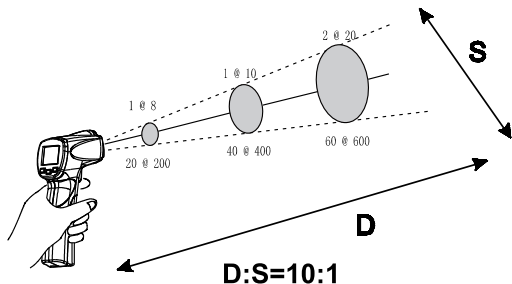

Locating a Hot or Cold Spot

Make sure that the target is larger than the spot size. The smaller the target, the closer you should be to it.

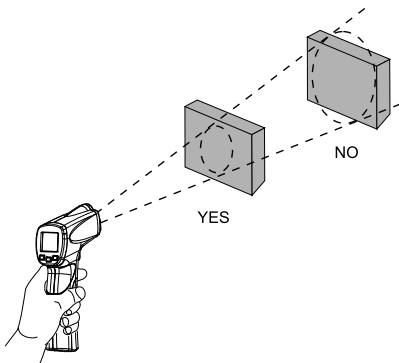

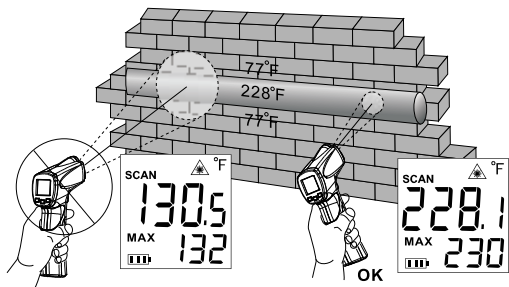

Emissivity

Emissivity describes the energy-emitting characteristics of materials. Most organic materials and painted or oxidized surfaces have an emissivity of about 0.95. If possible, to compensate for inaccurate readings that may result from measuring shiny metal surfaces, cover the surface to be measured with masking tape or flat black paint (150°C / 302°F) and use the high emissivity setting. Allow time for the tape or paint to reach the same temperatures as the surface beneath it. Measure the temperature of the tape or painted surface.

Reminders

1. Changes of surrounding ambient temperature can result in inaccurate reading, allow time for the instrument to adopt the change of ambient before use. Specified accuracy applies after 30 minutes when the instrument changes to a different environment ambient.

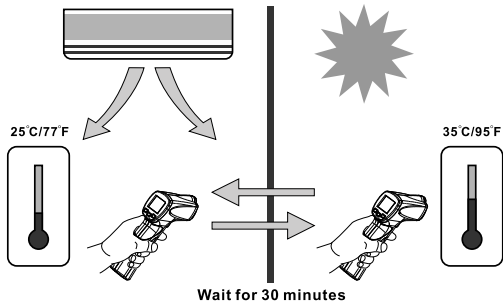

2. The instrument cannot measure through transparent surfaces such as glass. It will measure the surface temperature of the glass instead.

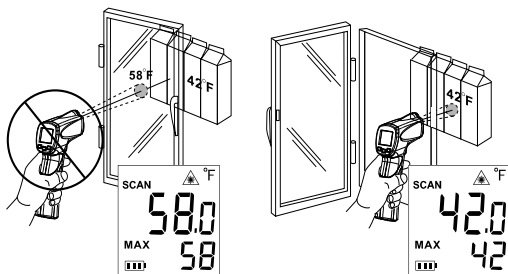

3. Not recommended for use in measuring shiny or polished metal surfaces (stainless steel, aluminum, etc.). See Emissivity.
4. Steam, dust, smoke, etc., can prevent accurate measurement by obstructing the instrument's optics.

SPECIFICATION

Function	Range
Temperature Range	0°F to 716°F -18°C to 380°C
Accuracy With ambient operating temperature of 21°C to 25°C (70°F to 77°F)	-18°C to 10°C (-0.4°F to 50°F): ±2%+1°C (2°F), or ±3°C (±6°F), whichever is greater >10°C to 380°C (>50°F to 716°F): ±2%, or ±2°C (±4°F), whichever is greater
Repeatability	±0.5% of reading or ±0.5°C (±1°F), whichever is greater
Display Resolution	0.1°C / 0.1°F
Spectral Response	8µm to 14µm
Laser Sighting	Single point laser
Laser Power	Output > 1mW Class 2, wavelength 630 to 670nm
Response Time (95%)	500ms
Distance to Spot (D:S)	10:1
Minimum Spot Size	20mm
Emissivity	0.95
Ambient Operating Temperature	0°C to 50°C 32°F to 120°F
Relative Humidity	0% to 75% non-condensing
Storage Temperature	-20°C to 65°C -4°F to 150°F (Battery not installed)
Temperature Display	°C or °F selectable
Display Hold	8 sec
MAX/MIN Temperature Display	√

Dual LCD Display	√
LCD Backlit	√
Low Battery Indication	√
Power	9V 6F22 alkaline battery or equivalent
Battery Life	10 hours with laser and backlight on 30 hours with laser and backlight off
Dimension (H x L x W)	Approx.153 x 108 x 40 mm (6.0 x 4.3 x 1.6 in)
Weight	Weight Approx.180 g (0.4 lb) with battery installed

MAINTENANCE

Lens Cleaning: Blow off loose particles using clean compressed air. Gently brush remaining debris away with a camel's hair brush. Carefully wipe the surface with a moist cotton swab. The swab may be moistened with water or rubbing alcohol.

Note: Do not use solvents to clean the plastic lens.

Case Cleaning: Use soap and water on a damp sponge or soft cloth.

Note: do not submerge the unit in water.

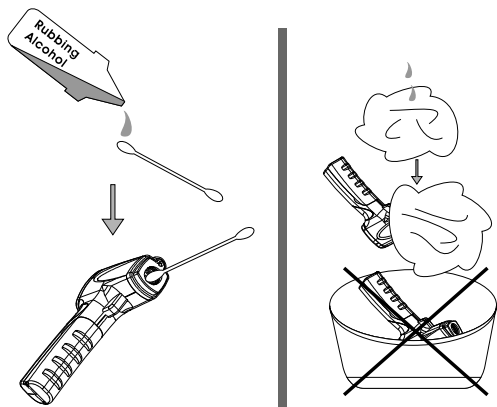

TROUBLE SHOOTING

Code	Problem	Action
OL	Target temperature is over range	Select target within specifications
-OL	Target temperature is under range	Select target within specifications
Battery indication 	Low battery	Check and/or replace battery
Blank display	Possible dead battery	Check and/or replace battery
Laser doesn't work	1.Low or dead battery 2.Ambient temperature above 40°C (104°F)	1.Replace battery 2.Use in area with lower

BATTERY REPLACEMENT

To install or change one 9V battery (see below):

1. Open the handle.
2. Install the battery noting its correct polarity.
3. Close and lock the handle.

Battery: 9V 6F22 alkaline battery or equivalent

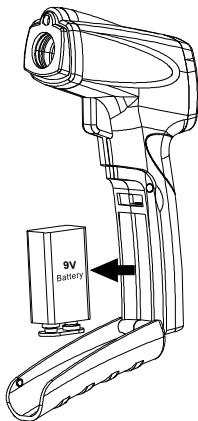
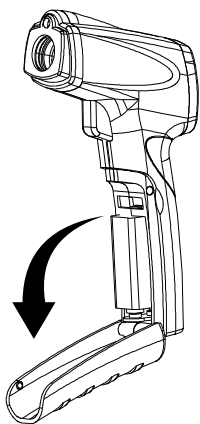

Visit www.Amprobe.com for

- Catalog
- Application notes
- Product specifications
- User manuals



Please Recycle