

Table of Contents

No.	Content	Page		
1	SCOPE			
	1.1 Description	4		
2	INPUT REQUIREMENTS			
	2.1 Input Voltage & Frequency	4		
	2.2 Input Current	4		
	2.3 Inrush Current	4		
	2.4 Stand-By Power	4		
3	OUTPUT FEATURES			
	3.1 Output Parameters	4		
	3.2 Turn On Delay	5		
	3.3 Hold Up Time	5		
	3.4 Typical Efficiency	5		
	3.5 Output Transient Response	5		
4	PROTECTION REQUIREMENT			
	4.1 Over-Voltage Protection	5		
	4.2 Over-Current Protection	5		
	4.3 Short-Circuit Protection	5		
5	ENVIRONMENTAL CONDITIONS			
	5.1 Operating	5		
	5.2 Non - Operating	5		
6	RELIABILITY AND QUALITY CONTROL			
	6.1 MTBF	6		
	6.2 Burn-In	6		
	6.3 Component Derating	6		
7	MECHANICAL CHARACTERISTICS			
	7.1 Physical Dimensions	6		
	7.2 Name Plate	6		
	7.3 Drop test	6		
8	SAFETY			
	8.1 Safety Standard	6		
	8.2 Insulation Resistance	7		
	8.3 Dielectric Strength (Hi-Pot)	7		
	8.4 Leakage Current	7		
9	EMC STANDARDS			
	9.1 EMI Standards	7		
	9.2 EMS Standards	7		
10	OTHER REQUIREMENTS			
	10.1 Hazardous Substances	8		
	10.2 Energy Efficiency	8		
11	APPENDIX			
	Appendix A	External View	9	
	Appendix B	Circuit Diagram	10	
	Appendix C	Name Plate Drawing	11	
	Appendix D	Packing Drawing	12	
	Appendix E	Test Report	13-16	
PRODUCT NO.:		REV.	DATE	SHEET
R026471L-V		0	Jun.22,2016	Page 1 of 16

Design Revision History

Rev.	Mark	Release Date	Description of Change		Revised By	Approved By
			Before	After		
0	/	Jun. 22,2016	Creation		何金沁	白德向

From this line belowing is empty

--	--	--	--	--	--	--

PRODUCT NO.:	REV.	DATE	SHEET
R026471L-V	0	Jun.22,2016	Page 2 of 16

Sample Delivery Information

1. Sample Background

Circuit Diagram Revision No: 0 PCB Layout Revision No: 0.1 BOM Revision No: 0 Transformer Revision No.: 0

2. Sample Purpose:

A. Function Sample

B. Final sample

C. Other Sample

3. Samples material instead of information

No.	Position No	Original design materials	The sample use material	Change Reason
1	none	none	none	none
2				
3				
4				
5				

4. The Change List Compare To Last Time Samples was:

The(**First**)Samples,This Time Samples' Tracking Number was:(**A01-A06**), Delivery Date:(**Jun.22,2016**).

No.	What is At Last Time Samples	What is At This Time Samples	Change Reason
1	none	none	none
2			
3			
4			
5			

Remark: Not final sample cannot be used to approve

PRODUCT NO.:	ISSUED BY	APPROVED BY	DATE	REV.	SHEET
R026471L-V	何金沁	白德向	Jun.22,2016	0	Page 3 of 16

1. SCOPE

This document details the electrical, mechanical and environmental specifications of a switching power supply.

1.1 Description

Wall Mount

Desk-Top

Open Frame

Others

2. INPUT REQUIREMENTS

2.1 Input Voltage & Frequency

The range of input voltage is from 90Vac to 264Vac

	Min.	Normal	Max.
Input Voltage	90Vac	100-240Vac	264Vac
Input Frequency	47Hz	50/60Hz	63Hz

2.2 Input Current

The maximum input current is 500mA max. at 100-240Vac .

Inrush Current

The inrush current will not exceed 120A at 100-240Vac input and Max load for a cold start at 25°C.

2.4 Stand-By Power

The input power should be less than with No-Load.

3. OUTPUT FEATURES

3.1 Output Parameters

	Output Data	Spec. Limit			Test Condition
		Min. Value	Typical	Max. Value	
3.1.1	12.0Vdc				
3.1.2	Output Voltage	11.4Vdc	12.0Vdc	12.6Vdc	0 ~ 2.0A Loading
3.1.3	Output Load	0.0A	—	2.0A	
3.1.4	Ripple and Noise	—	—	150mVp-p	20MHz Bandwidth 10uF Ele. Cap.0.1uF Cer. Cap.
3.1.5	Output Overshoot	—	—	10%	MAX. load(2.0A) & 100-240Vac

PRODUCT NO.:	REV.	DATE	SHEET
R026471L-V	0	Jun.22,2016	Page 4 of 16

3.2 Turn On Delay

During turn on and turn off, no output voltage shall exceed its nominal voltage by more than **10%** and no output shall change its polarity with respect to its return line. All outputs shall reach their steady state values within **3** seconds of turn on.

3.3 Hold Up Time

10 ms minimum at **115Vac/60Hz** input at maximum load, and **20** ms minimum at **230Vac/50Hz** input at maximum load.

3.4 Typical Efficiency

The efficiency (watts out / watts in) shall be higher than _____ typical while measuring at nominal line and maximum load condition, test in 1 minute after power on.

3.5 Output Transient Response

The power supply shall maintain output transient response time within **10ms** with a loading current change from 20% to 80% of maximum current and 0.5A/μs rise up /drop down test at end of output terminal.

4. PROTECTION REQUIREMENT

4.1 Over-Voltage Protection

Over-voltage protection shall be included in the adaptor circuit. A single component failure must not cause an over voltage.

4.2 Over-Current Protection

The adaptor must have a current limiting function on the output voltage. in overload mode, the output must drop to a low voltage.

4.3 Short-Circuit Protection

The adaptor must withstand a continuous short circuit on the output without damage.

5. ENVIRONMENTAL CONDITIONS

5.1 Operating

The power supply shall be capable of operating normally in any mode without malfunction happens in the following environmental conditions.

5.1.1 Operating Temperature: 0°C ~40°C (Can operate normally)

Relative Humidity: 10% ~ 90%

Altitude: Sea level to 2,000 m.

5.1.2 Vibration: 1.0mm, 10 –55Hz, 15 minutes per cycle for each axis (X, Y, Z).

5.1.3 Cooling: Natural convection cooling

5.2 Non - Operating

The power supply shall be capable of withstanding the following environmental conditions extended periods of time, without sustaining electrical or mechanical damage and subsequent operational deficiencies.

PRODUCT NO.:	REV.	DATE	SHEET
R026471L-V	0	Jun.22,2016	Page 5 of 16

5.2.1 Storage Temperature: -30°C ~ 70°C

5.2.2 Relative Humidity: 10% ~ 90%

5.2.3 Altitude: Sea level to 2,000 m.

5.2.4 Vibration and Shock:

The power supply shall be designed to withstand normal transportation vibration per MIL-STD-810D, method 514 and procedures X, as it is mounted in the chassis assembly and packed for shipping.

6. RELIABILITY AND QUALITY CONTROL

6.1 MTBF

When the power supply is operating within the limits of this specification the MTBF shall be at least 50,000 hours at 25°C (MIL-HDBK-217F).

6.2 Burn-In

The power supply shall withstand a minimum of 2 hours Burn-In test under full load at 35°C ~40°C room temperatures, after test, product shall operate normally.

6.3 Component Derating

Semiconductor junction temperatures shall not exceed the manufacturer's maximum thermal rating.

7. MECHANICAL CHARACTERISTICS

7.1 Physical Dimensions

The detail dimension of the power supply is drawn on APPENDIX A.

7.2 Nameplate

The label of the power supply, please see APPENDIX C.

7.3 Drop test

Dropped freely from 1 m (for wall mount product) height onto the surface is consisted of hardwood 13 mm thick, mounted on two layers of plywood each 19-20 mm thick, all supported on concrete floor 1 time from 3 different surface, after test, it's no safety damage for product.

8. SAFETY

8.1 Safety Standard

The power supply shall be certified under the following international regulatory standards

PRODUCT NO.:	REV.	DATE	SHEET
R026471L-V	0	Jun.22,2016	Page 6 of 16

Item	Country	Certified	Standard
CE	Europe	Approved	EN60950-1

8.2 Insulation Resistance

Input to output: **10 MΩ** min. at **500 VDC**.

8.3 Dielectric Strength (Hi-Pot)

Primary to Secondary **DC4242V,3.5mA** 1 minute for type test,
DC4500V,3.5mA 2 seconds for product.

8.4 Leakage Current

The leakage current shall be less than **0.25mA** for **Class II** when the power supply is operated maximum input voltage and maximum frequency.

9. EMC STANDARDS

9.1 EMI Standards

The power supply shall meet the radiated and conducted emission requirements for **EN55022**.

9.2 EMS Standards(**EN55024**)

The power supply shall meet the following EMS standards

9.2.1 IEC61000-4-2 Electrostatic Discharge (ESD)

Static – discharge test by contact or air should be conducted with Static – discharge tester, energy storage capacitance of 150pF, and discharge resistance of 330Ω.
8KV air discharge, **4KV** contact discharge, Performance Criterion B.

9.2.2 IEC61000-4-3 Radiated Electromagnetic Fields(RS)

Radio- frequency Electromagnetic Field Susceptibility Test, RS, 80-1000MHz,3V/m, 80%AM(1KHz), Performance Criterion A.

9.2.3 IEC61000-4-4 Electrical Fast Transient / Burst (EFT)

Power Line to Line: **1KV**
Performance Criterion B.

PRODUCT NO.:	REV.	DATE	SHEET
R026471L-V	0	Jun.22,2016	Page 7 of 16

- 9.2.4 IEC61000-4-5 Lightning Surge Attachment
Lightning Surge voltage of differential and common modes shall be applied across AC input lines and across input and frame ground.
Power Line to Line: **1KV**
Performance Criterion B.
- 9.2.5 IEC61000-4-6 Conducted Radio Frequency Disturbances (CS)
Conducted Radio Frequency Disturbances Test, CS, 0.15-80 MHz, 3V/m, 80%AM, 1KHz, Performance Criterion A.
- 9.2.6 IEC61000-4-11 Voltage Dips/Short Interruption/Variations
Voltage Dips, 30% reduction- 10ms, Performance Criterion B, 60% Reduction – 100ms, Performance Criterion C, Voltage Interruptions>95% Reduction- 5000ms, Performance Criterion C.

10. OTHER REQUIREMENTS

10.1 Hazardous Substances

The components and used materials shall be in compliance with

- EU Directive 2011/65/EU "RoHS"
 EU Directive 2012/19/EU "WEEE"
 Halogen Free
 REACH

10.2 Energy Efficiency

10.2.1 The No-Load power consumption shall be less than **0.075W** at input **115/230Vac,60/50Hz.**

10.2.2 The average active mode efficiency shall be higher than **86.19%** at input **115/230Vac,60/50Hz.**

10.2.3 International Efficiency Level **VI** .
 Korea Energy Efficiency Label

10.2.4 This power supply is therefore in compliance with the requirements of

- California Energy Commission Energy Efficiency requirements for external power supplies (CEC)
 The Power Supply are in accordance with U.S. Department of Energy(DOE) 10 CFR Part 430 .
 Canada's Energy Efficiency Regulations for External Power Supplies
 Australian and New Zealand Energy Performance Requirements for external power supplies (MEPS,AS/NZS 4665.1,AS/NZS 4665.2)
 China Energy Efficiency requirements for external power supplies (GB20943-2013)
 Korea regulation on Energy Efficiency Labeling and Standards for external power supplies (MKE's Notification 2008-99)
 Implementing Directive 2009/125/EC of the European Parliament and of the Council with regard to ecodesign requirements for no-load condition electric power consumption and average active efficiency of external power supplies (No 278/2009, Stage 2)

PRODUCT NO.:	REV.	DATE	SHEET
R026471L-V	0	Jun.22,2016	Page 8 of 16

APPENDIX A

Mechanical Dimensions(Unit: mm) Tolerance Of unspecified Parts:±1.5mm

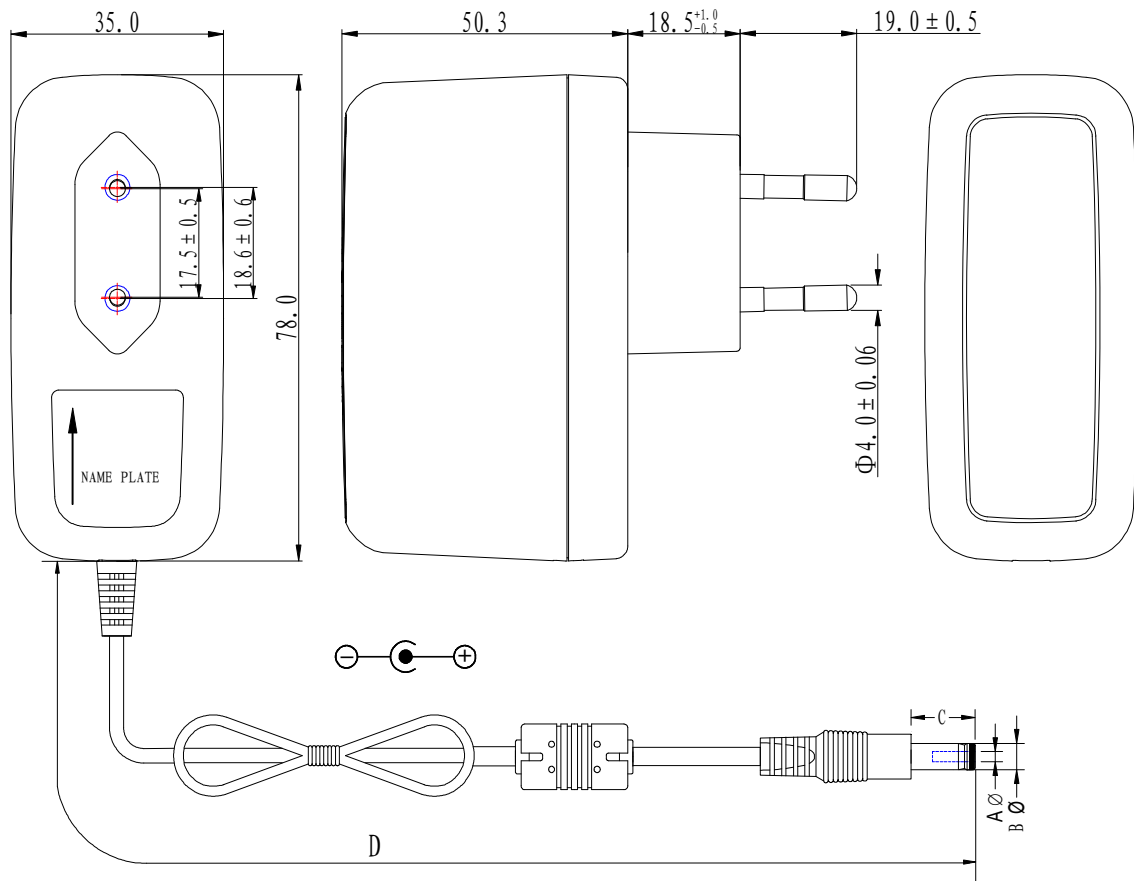

	ΦA	ΦB	C	D
DIMENSION	2.1	5.5	10.0	1830
TOLERANCE	+0.1/-0	±0.1	±0.5	min.
REMARK	AWG20#/2C UL1185 BLACK			

PRODUCT NO.:	REV.	DATE	SHEET
R026471L-V	0	Jun.22,2016	Page 9 of 16

APPENDIX B

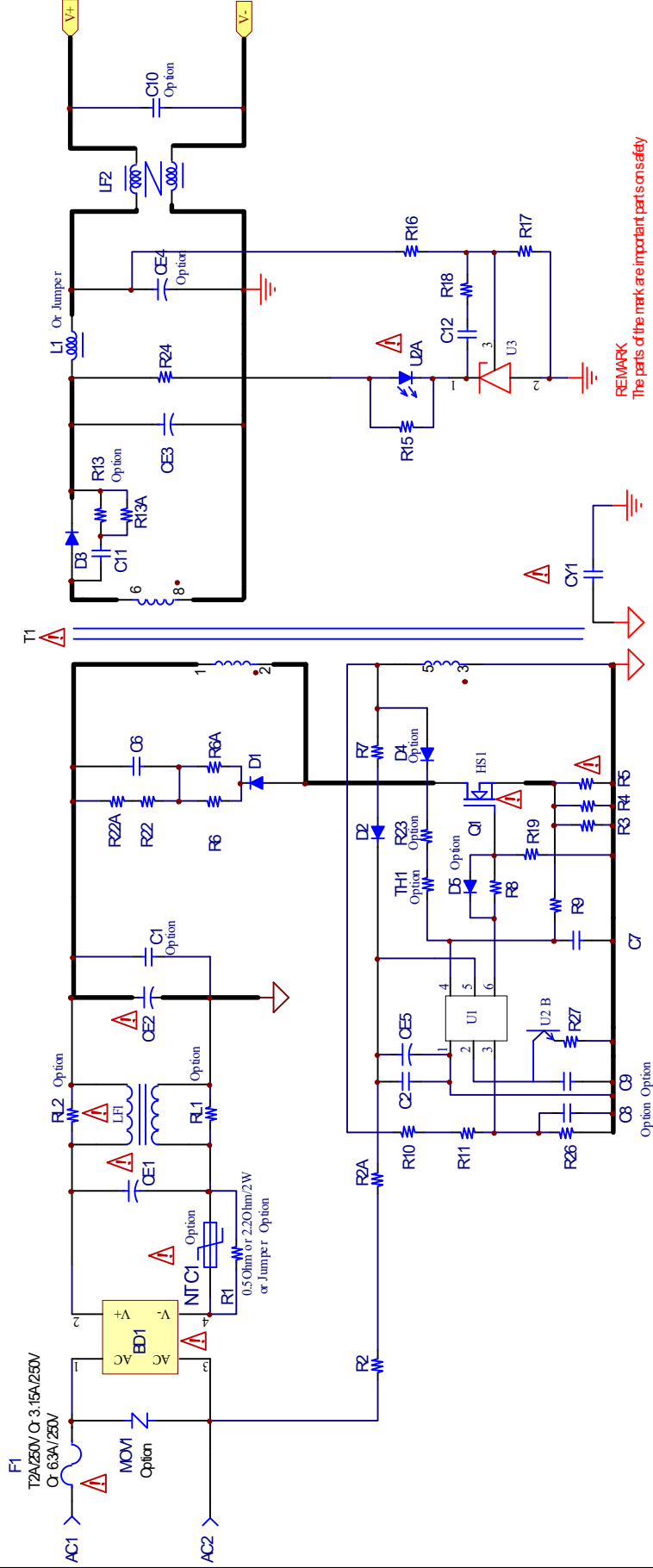

REMARK
The parts of the mark are important parts on safety

CIRCUIT DIAGRAM	DATE	Jun.22,2016	REV.	0
	DESIGN	何金沁	APPROVE	白德向
PRODUCT NO.:		REV.		0
R026471L-V		DATE	SHEET	
		Jun.22,2016	Page	10 of 16

APPENDIX C

Name Plate:

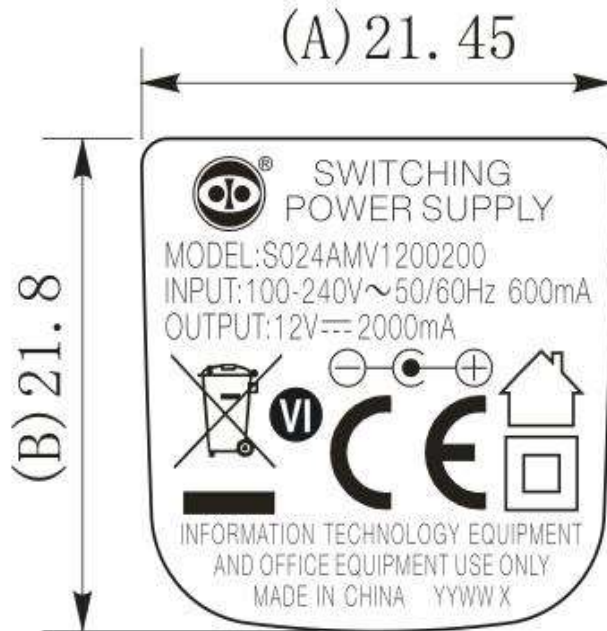

DATE CODE:

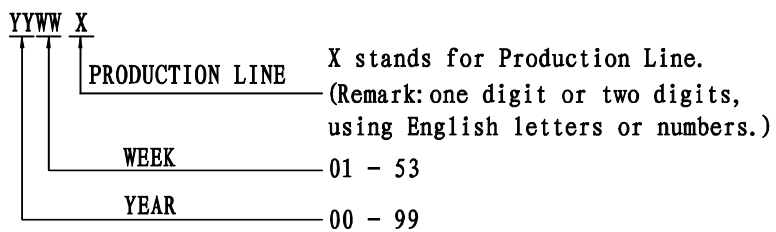

Unit: mm

Word Color: **Grey (Laser Print)**

* Please Advise If Any Comments About The Name Plate Information.

Otherwise, This Information Is Defaulted As Customer Approval,

And Will Be Applied To Production .

PRODUCT NO.:	REV.	DATE	SHEET
R026471L-V	0	Jun.22,2016	Page 11 of 16

APPENDIX D

PRODUCT:

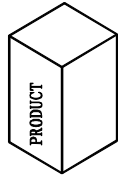

PLASTIC BAG:

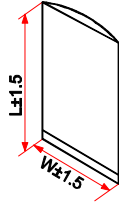

WHITE BOX

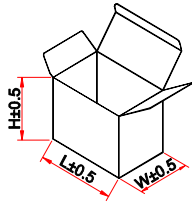

CARDBOARD:

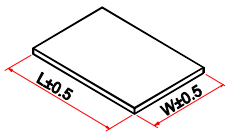

CARTON:

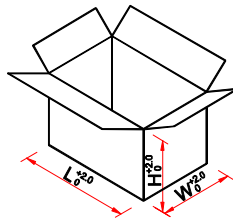

DIMENSION(UNIT IN cm):

	L	W	H
PLASTIC BAG	22.0	15.0	
WHITE BOX	9.3	4.3	11.8
PAPERBOARD	48.0	38.0	
CARTON	49.0	39.0	24.0

PACKING METHOD:

PAPERBOARD PLACEMENT METHOD	PUT A PAPERBOARD OVER AND UNDER THE PRODUCTS OF EACH LAYER, TOTAL 2PCS.
PACKING METHOD	16PCS/LAYER X 5 LAYERS
QTY	80PCS
N.W./PC	g
G.W./CARTON	Kg

REMARK:

1. STORAGE CONDITION

TEMPERATURE: -10℃ ~ +60℃

RELATIVE HUMIDITY: 30% ~ 80%

2. STORAGE PERIOD: 6 MONTHES

3. ANTISTATIC: NO REQUIREMENT

4. PLEASE ADVISE IF ANY COMMENTS ABOUT THE PACKING INFORMATION.

OTHERWISE, THIS INFORMATION IS DEFAULTED AS CUSTOMER APPROVAL,

AND WILL BE APPLIED TO PRODUCTION.

PRODUCT NO.:	REV.	DATE	SHEET
R026471L-V	0	Jun.22,2016	Page 12 of 16

APPENDIX E

SAMPLE PRIMARY TEST REPORT

CUSTOMER		DIGIMAX SRL											
MODEL NO.		S024AMV1200200				PRODUCT NO.:				R026471L-V			
Test Items.	Test Condition	Unit	Sample Number and Test Result										Pass/Fail
			1#	2#	3#	4#	5#						
Unload output voltage/ (0.0A) 11.4Vdc - 12.6Vdc	90Vac	V	12.21	12.22	12.22	12.23	12.24						Pass
	132Vac	V	12.21	12.22	12.22	12.23	12.24						Pass
	180Vac	V	12.21	12.22	12.22	12.23	12.24						Pass
	264Vac	V	12.21	12.22	12.22	12.23	12.24						Pass
Rated load output voltage/ (2.0A) 11.4Vdc - 12.6Vdc	90Vac	V	11.92	11.94	11.97	11.95	11.96						Pass
	132Vac	V	11.92	11.94	11.97	11.95	11.96						Pass
	180Vac	V	11.92	11.94	11.97	11.95	11.96						Pass
	264Vac	V	11.92	11.94	11.97	11.95	11.96						Pass
Output ripple & noise voltage ≤ 150mV (test at full loading)	90Vac	mV	78	79	80	81	82						Pass
	132Vac	mV	83	77	86	82	75						Pass
	180Vac	mV	82	79	80	81	84						Pass
	264Vac	mV	78	79	80	81	82						Pass
Short-circuit protection test (Short at end of DC plug)	90Vac	W	0.01	0.02	0.04	0.04	0.04						-
	264Vac	W	0.73	0.64	0.53	0.61	0.51						-
Over current protection (Ocp ≤ A)	90Vac	A	3.05	3.09	3.02	3.02	3.09						-
	264Vac	A	2.96	2.98	2.90	2.96	2.92						-
IC Vcc voltage test/ /Max. load (Specs ≤ V)	90Vac	v	17.86	18.54	19.09	19.04	18.99						-
	264Vac	v	17.63	18.79	19.03	19.27	19.09						-
IC Vcc voltage test/Min. load (Specs ≥ V)	90Vac	v	14.59	14.67	14.73	14.58	14.61						-
	264Vac	v	14.54	14.66	14.71	14.55	14.52						-
Hi-pot test	4242Vdc/3.5mA/ 1Minute		OK	OK	OK	OK	OK						Pass
TEST BY	CHECKED BY	APPROVED BY	DATE				REV.	SHEET					
杨盛威	何金沁	白德向	Jun.22,2016				0	Page 13 of 16					

APPENDIX E

SAMPLE TEST REPORT

CUSTOMER:		DIGIMAX SRL									
TEN PAO MODEL NO.:		S024AMV1200200			PRODUCT NO.:				R026471L-V		
Items No.	Test Items	Unit	Test condition & result						Spec. Limit	Pass/ Fail	
			90Vac	115Vac	132Vac	180Vac	230Vac	264Vac			
1	Unload input current	mA	10.97	13.93	15.96	18.03	23.09	26.46	-	-	
2	Unload input power	W	0.03	0.03	0.03	0.04	0.05	0.07	≤0.075W (115/230Vac)	Pass	
3	Rated load input current	mA	560.80	468.80	432.10	380.90	307.07	273.96	≤600mA (100 - 240Vac)	Pass	
4	Rated load input power	W	27.65	27.35	27.32	27.15	27.08	27.30	-	-	
5	Unload output voltage(0.0A)	V	12.30	12.30	12.30	12.30	12.30	12.30	11.4V -12.6V	Pass	
6	Rated load output voltage(2.0A)	V	11.80	11.82	11.82	11.81	11.81	11.80	11.4V -12.6V	Pass	
7	Output ripple&noise voltage(2.0-0A)	mV	74.0	76.9	73.8	79.4	79.4	77.8	≤150.0mVp-p	Pass	
8	Output transient response(20-80%)	mS	6.01	6.01	6.01	6.01	6.01	6.01	≤10mS	Pass	
9	Short-circuit test (Pin&lout)	W	0.06	0.08	0.32	0.58	0.92	1.29	-	-	
		A	hiccup	hiccup	hiccup	hiccup	hiccup	hiccup	-	-	
10	Over current protection	A	3.02	3.05	3.08	3.03	3.01	2.97	-	-	
11	Over voltage protection	V	15.47	15.47	15.47	15.47	15.47	15.47	-	-	
12	Output overshoot/Max load	%	2.20%	2.20%	2.20%	2.20%	2.20%	2.20%	≤10.0% (100-240Vac)	Pass	
13	Turn on delay time	mS	2740.0	1827.9	1563.0	1138.8	875.7	749.6	≤3000.0mS	Pass	
14	Hold up time	mS	10.12	19.34	20.46	45.88	81.57	112.00	≥10mS/(115Vac) ≥20mS/(230Vac)	Pass	
15	Efficiency(Full load)	%	85.35%	86.44%	86.53%	87.00%	87.22%	86.45%	-	-	
16	Mech. Dimension	mm	78.3			35.2			L:78.0±1.5; W 35.0±1.5		Pass
			50.5			-			H :50.3±1.5		Pass
			19.0			-			AC PIN:19.0±0.5		Pass
17	DC cord and DC connector	mm	DC cord:AWG20#/2C UL1185,LENGTH:1850mm.						1830mm Min.		Pass
			DC conn.:Inside(+) Outside(-),Dimension conform with spec. limit.								
18	Hi-pot test	Pri. to Sec:4242Vdc,1Minute, Cut off current≤3.5mA(Test result: 0.04mA)								Pass	
19	Drop test	Drop test 3 Times (High: 1000mm), The sample OK									
20	Max. and Light load change test	Max. load to Light load: OK Light load to max. load: OK (90-264Vac)									
21	Appe. label and fusion	Appearance: OK, Label: OK, Fusion: OK									
22	Mosfet(IC)/Vds(normal:95% ,other:100%)	V	589.0	596.0	617.0	630.0	612.0	Mosfet spec. 650V	Derating≤95% &100% Max. Volt.	Pass	
			normal	start up	short	ocp	max/min				
23	Diode /Vrr(normal:90% ,other:100%)	V	76.5	77.9	86.1	87.1	85.6	Diode spec. 100V	Derating≤90% &100% Max. Volt.	Pass	
			normal	start up	short	ocp	max/min				
TEST BY		CHECKED BY	APPROVED BY			DATE	REV	SHEET			
杨盛威		何金沁	白德向			Jun.22,2016	0	Page 14 of 16			

APPENDIX E

SAMPLE TEST REPORT

CUSTOMER: DIGIMAX SRL

TEN PAO MODEL NO.: S024AMV1200200 **PRODUCT NO.:** R026471L-V

1.TEST STANDARD: Implementing Directive 2009/125/EC of the European Parliament and of the Council

2. Product Specification:

Input voltage, frequency, current: 100-240VAC 50/60HZ 500mA Output voltage, current: 12.0VDC/2.0A

3.TEST METHOD:

3.1. Under input 230VAC / 50Hz, output normal load, the EUT continuous operating for 30 minutes.

3.2. Under input 115VAC / 60Hz and 230VAC / 50Hz, the EUT is measured at 100%, 75%, 50% and 25% of rated output current. Record values are output voltage, output current, input power, input current. Then calculating average efficiency at four active mode load conditions.

3.3. Input 115VAC / 60Hz and 230VAC / 50Hz, test the input power, input current, output voltage in the no-load condition.

4.TEST DATA: (Room temperature: 25-30°C, relative humidity : 10-90%).

4.1 Input voltage, frequency 115V,60Hz:

Sample No.	Item	Unload	25%*I _L	50%*I _L	75%*I _L	100%*I _L	Average	
1#	Output	Current(mA)	0	500	1000	1500	2000	/
		Voltage(V)	12.28	12.17	12.06	11.95	11.91	/
		Power(W)	/	/	/	/	/	/
	Input	Power(W)	0.03	6.84	13.72	20.38	27.54	/
		THD _V (%)	/	/	/	/	/	/
		True PF	0.031	0.3845	0.4375	0.4861	0.5184	/
		Current(mA)	14.98	159.03	277.68	376.10	472.10	/
	Efficiency(%)		/	88.96%	87.90%	87.95%	86.49%	87.83%
	2#	Output	Current(mA)	0	500	1000	1500	2000
Voltage(V)			12.28	12.17	12.06	11.95	11.93	/
Power(W)			/	/	/	/	/	/
Input		Power(W)	0.03	6.86	13.77	20.33	27.51	/
		THD _V (%)	/	/	/	/	/	/
		True PF	0.03	0.3842	0.4402	0.4885	0.5197	/
		Current(mA)	14.64	159.14	275.28	374.30	470.70	/
Efficiency(%)		/	88.70%	87.58%	88.17%	86.73%	87.80%	
3#		Output	Current(mA)	0	500	1000	1500	2000
	Voltage(V)		12.27	12.16	12.05	11.94	11.83	/
	Power(W)		/	/	/	/	/	/
	Input	Power(W)	0.03	6.79	13.71	20.32	27.52	/
		THD _V (%)	/	/	/	/	/	/
		True PF	0.03	0.3892	0.4402	0.4881	0.5206	/
		Current(mA)	14.79	158.02	277.59	376.00	471.40	/
	Efficiency(%)		/	89.54%	87.89%	88.14%	85.97%	87.89%
	Energy Efficiency (Min.): 87.80%		Efficient Level VI: 86.19%			JUDGEMENT	Pass/Fail	Pass

TEST BY	CHECKED BY	APPROVED BY	DATE	REV.	SHEET
杨盛威	何金沁	白德向	Jun.22,2016	0	Page 15 of 16

APPENDIX E

SAMPLE TEST REPORT

CUSTOMER: DIGIMAX SRL

TEN PAO MODEL NO.: S024AMV1200200 **PRODUCT NO.:** R026471L-V

4.2 Input voltage, frequency 230V,50Hz:

Sample No.	Item	Unload	25%*I _L	50%*I _L	75%*I _L	100%*I _L	Average		
1#	Output	Current(mA)	0	500	1000	1500	2000	/	
		Voltage(V)	12.29	12.17	12.06	11.95	11.84	/	
		Power(W)	/	/	/	/	/	/	
	Input	Power(W)	0.06	6.87	13.62	20.4	27.12	/	
		THD _V (%)	/	/	/	/	/	/	
		True PF	0.021	0.3463	0.374	0.3917	0.4041	/	
		Current(mA)	23.02	90.80	163.49	232.93	304.07	/	
	Efficiency(%)		/	88.57%	88.55%	87.87%	87.32%	88.08%	
	2#	Output	Current(mA)	0	500	1000	1500	2000	/
			Voltage(V)	12.28	12.17	12.06	11.94	11.83	/
Power(W)			/	/	/	/	/	/	
Input		Power(W)	0.06	6.89	13.62	20.35	27.08	/	
		THD _V (%)	/	/	/	/	/	/	
		True PF	0.02	0.3475	0.375	0.3930	0.4026	/	
		Current(mA)	24.41	90.70	163.81	233.14	305.14	/	
Efficiency(%)		/	88.32%	88.55%	88.01%	87.37%	88.06%		
3#		Output	Current(mA)	0	500	1000	1500	2000	/
			Voltage(V)	12.27	12.16	12.05	11.94	11.83	/
	Power(W)		/	/	/	/	/	/	
	Input	Power(W)	0.06	6.88	13.59	20.36	27.09	/	
		THD _V (%)	/	/	/	/	/	/	
		True PF	0.021	0.3475	0.3765	0.3907	0.4063	/	
		Current(mA)	24.63	90.52	163.50	231.60	303.45	/	
	Efficiency(%)		/	88.37%	88.67%	87.97%	87.34%	88.09%	
	Energy Efficiency (Min.) : 88.06%		Efficient Level VI: 86.19%			JUDGEMENT	Pass/Fail	Pass	

5.EQUIPMENTS LIST:

Power meter:WT210 AC source: AFC-1200W Electronic load: Prodigit 3300C

6.REMARK:

First Function Sample

TEST BY	CHECKED BY	APPROVED BY	DATE	REV.	SHEET
杨盛威	何金沁	白德向	Jun.22,2016	0	Page 16 of 16