



Board-to-Board Link; Pin spacing 4 mm; 1-pole; Length: 28 mm

Item No.: 2060-951/028-000



Board-to-Board Link; Pin spacing 4 mm; 1-pole; Length: 28 mm

Marking

RoHS ✓
Compliant

Business data

Supplier	WAGO
Item no.	2060-951/028-000
GTIN / EAN	4055143303880
Content	1
Order amount	1,500
Customer item number	

Notes

Item description: Board-to-board link simplifies in-line assembly of LED modules Easy push-in termination and disconnection without push-button actuation Recommendation: Only suitable for 2060-45x, not for 2060-40x.

Technical data

Miscellaneous

Packaging type	Box
Ratings per	IEC/EN 60664-1
Rated voltage (III / 3) [V]	63 [V]
Rated impulse voltage (III / 3) [kV]	2.5 [kV]
Rated voltage (III/2) [V]	160 [V]

Technical data	
<i>Rated impulse voltage (III / 2) [kV]</i>	<i>2.5 [kV]</i>
<i>Rated voltage (II / 2) [V]</i>	<i>320 [V]</i>
<i>Rated impulse voltage (II / 2) [kV]</i>	<i>2.5 [kV]</i>
<i>Rated current [A]</i>	<i>9 [A]</i>
<i>Legend (ratings)</i>	<i>(III / 2) Overvoltage category III / Pollution degree 2</i>
<i>No. of poles</i>	<i>1</i>
<i>Total number of potentials</i>	<i>1</i>
<i>Pin spacing</i>	<i>4 mm (0.157 in)</i>
<i>Width</i>	<i>3.4 mm / 0.134 Inch</i>
<i>Height</i>	<i>2.6 mm / 0.102 Inch</i>
<i>Depth</i>	<i>28 mm / 1.102 Inch</i>
<i>Color</i>	<i>white</i>
<i>Material group</i>	<i>I</i>
<i>Insulating material</i>	<i>Polyamide 66 (PA 66)</i>
<i>Flammability class per UL94</i>	<i>V0</i>
<i>Contact material</i>	<i>Copper alloy</i>
<i>Contact plating</i>	<i>silver-plated</i>
<i>Fire load [MJ]</i>	<i>0.001 [MJ]</i>
<i>Weight [g]</i>	<i>0.23 [g]</i>
<i>Limit temperature range</i>	<i>-60 ... 105 °C</i>
<i>Pin spacing from [in]</i>	<i>0.157 [in]</i>
<i>Pin spacing from [mm]</i>	<i>4 [mm]</i>
<i>Main product function</i>	<i>Board-to-Board Link</i>
<i>Product type</i>	<i>Accessories</i>
<i>Geeignet für</i>	<i>für SMD-Leiterplattenklemmen mit Betätigungsdrückern</i>

Images & drawings

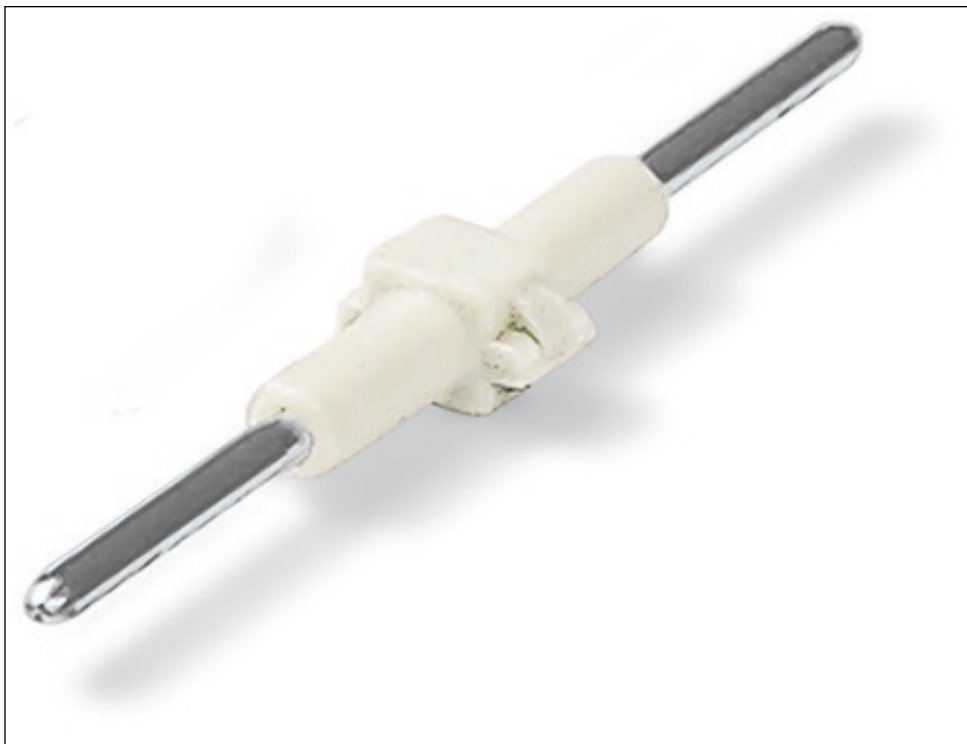

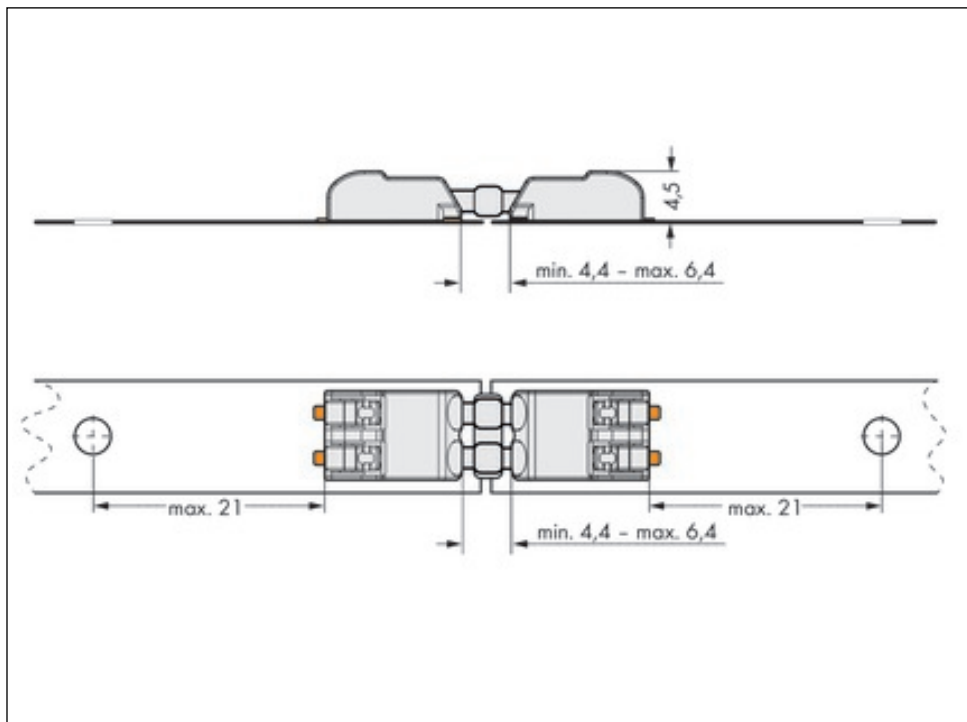
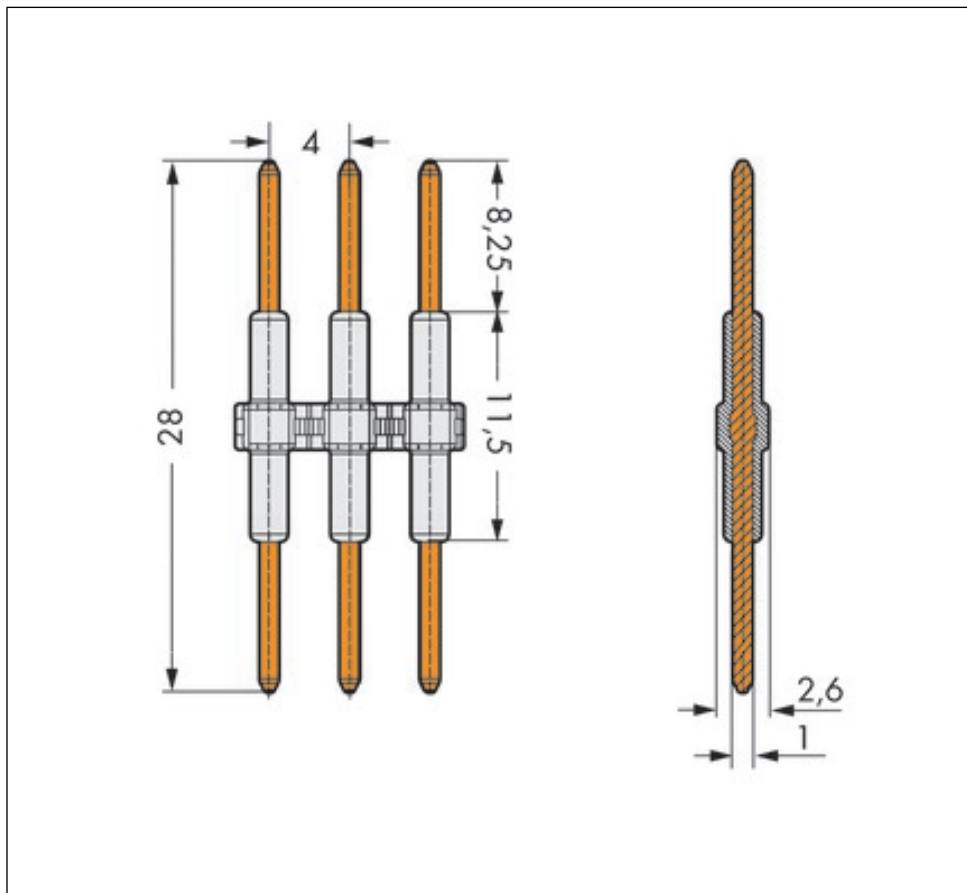

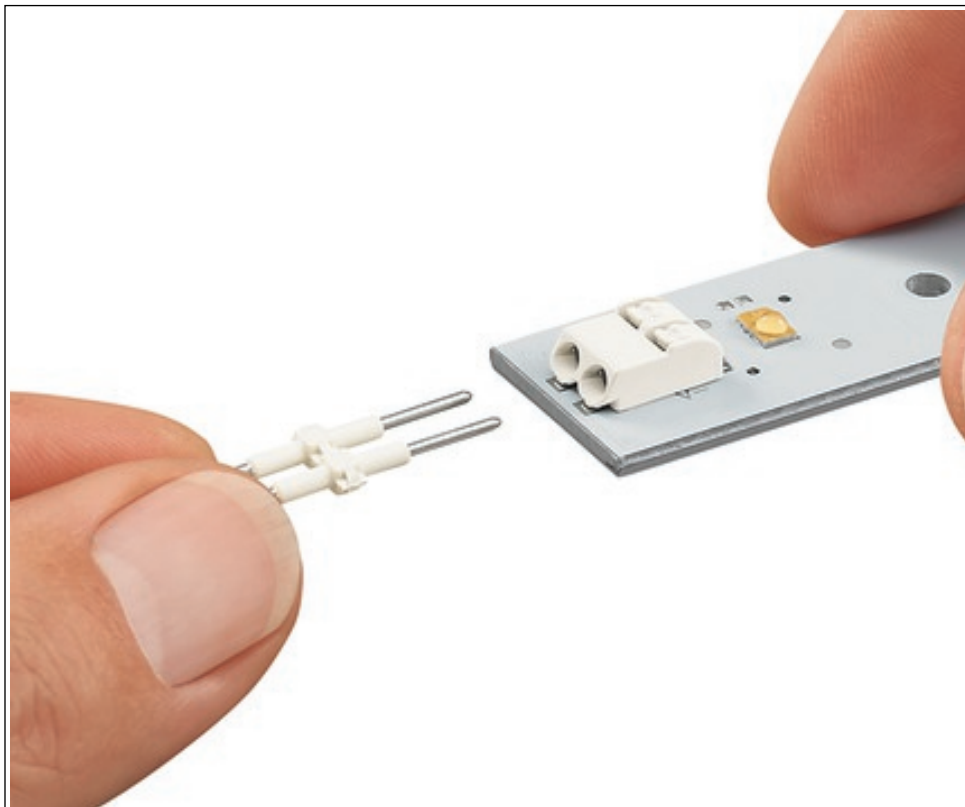
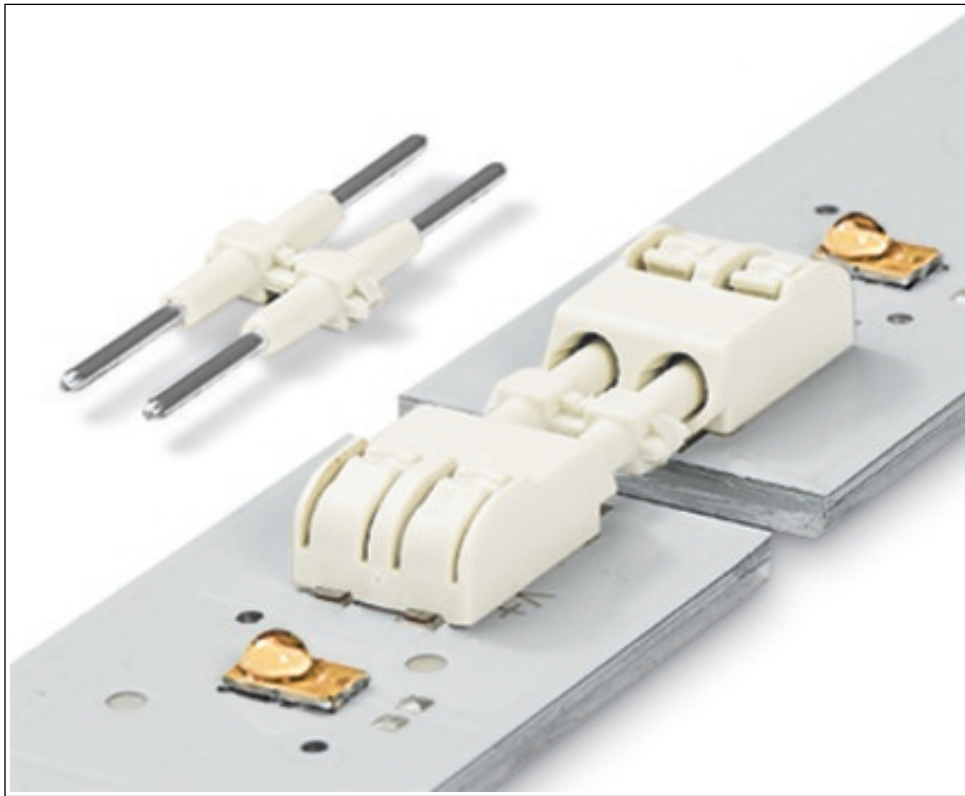

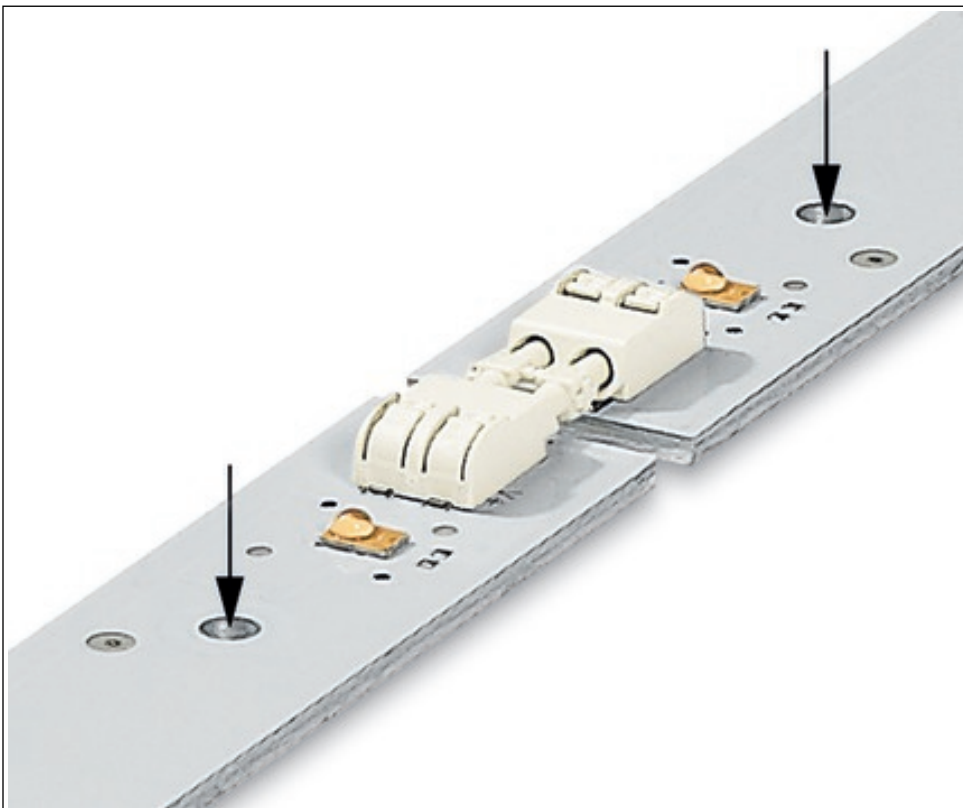
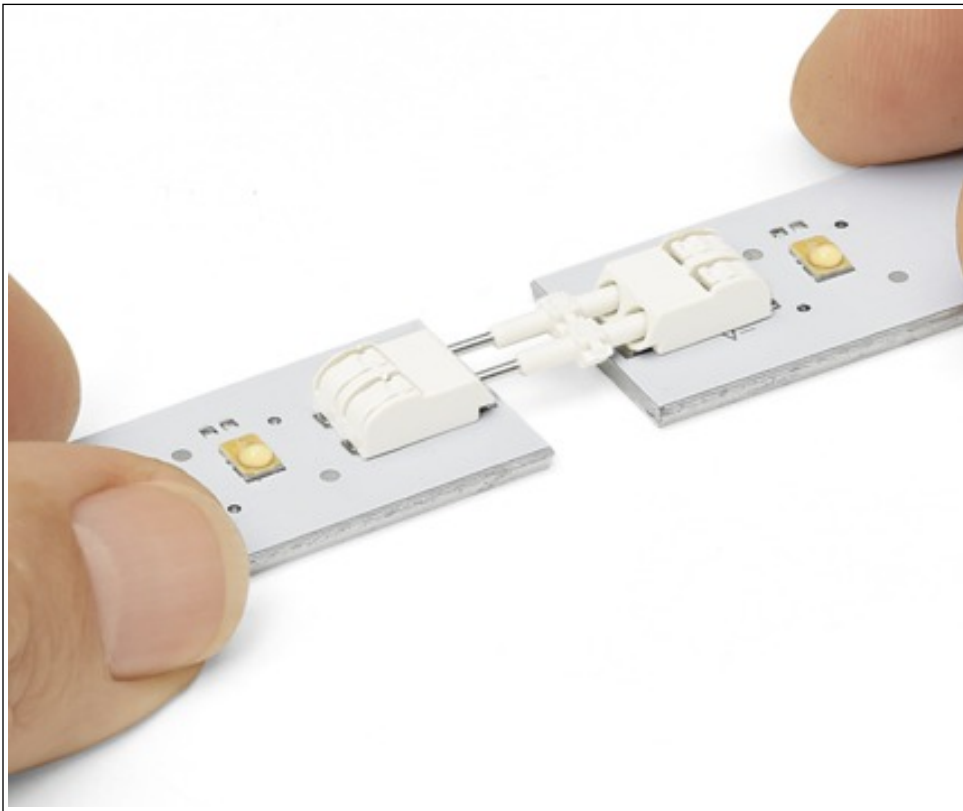

Address

WAGO Kontakttechnik GmbH & Co. KG

Hansastr. 27

32423 Minden

Telefon: 0571/887-0

Fax: 0571/887-169

<http://www.wago.com>

© WAGO Kontakttechnik GmbH & Co. KG

Technische Änderungen und Irrtümer vorbehalten.