

LAMINATED TRANSFORMERS

Type EE20 / 4 - 0.08VA









AGENCY APPROVALS  

1. UL 506, File E113449 

2. UL 1585, File E175197 

Primary (V)	Secondary (V / mA)	No-Load Voltage (V)	Schematic No.	Part Number	Agency Approvals
230	6 / 13.30	9.20	1	020-5480.0	1/2
230	9 / 8.88	13.60	1	020-5481.0	1/2
230	12 / 6.67	18.30	1	020-5482.0	1/2
230	15 / 5.33	22.60	1	020-5483.0	1/2
230	18 / 4.44	27.20	1	020-5484.0	1/2
115	6 / 13.3	9.20	1	020-5470.0	1/2
115	9 / 8.88	13.60	1	020-5471.0	1/2
115	12 / 6.67	18.30	1	020-5472.0	1/2
115	15 / 5.33	22.60	1	020-5473.0	1/2
115	18 / 4.44	27.20	1	020-5474.0	1/2

-  Frequency 50/60Hz
-  Potted under vacuum
-  Split-bobbin
-  Temperature class ta 70°C/B
-  Short-circuit-proof (where noted: 1/2/3* under Agency Approvals)
-  Weight: 0.018kg
-  Packaging unit: 40 pieces (tray)

Mechanical

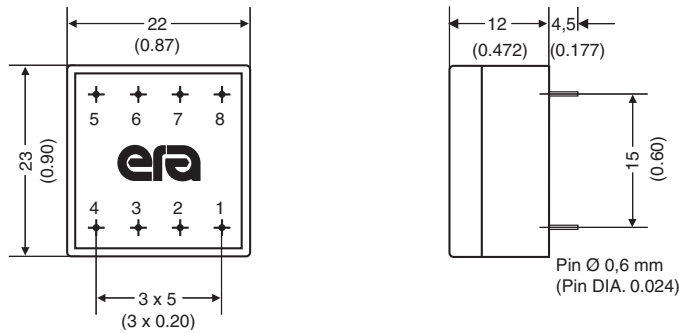

Schematic

